

# Product Overview



**Colorbond**<sup>®</sup>  
THE COLOURS OF AUSTRALIA SINCE 1966

**BONDOR**<sup>®</sup>  
Leaders in Thermal & Architectural Building Solutions

Build Better



Leaders in Thermal & Architectural Building Solutions

## Contents

Introduction .....	3
Why Bondor® are the Market Leaders .....	3
Support for Australian Standards & Local Manufacturing.....	3
Global Experience .....	3
Still beautiful, after all these years.....	4

### Proven Partnerships.....4

BlueScope Steel .....	4
IPCA .....	4
Engineers Australia.....	4
AIA .....	4

### Quality Assurance .....5

Codemark.....	5
Factory Mutual (FM) .....	5
Green Rate .....	5
NATA .....	5

### Build Better with Bondor® .....6

Fast Build Times .....	6
Cost Effective .....	6
Design Flexibility .....	6
Low Maintenance & Hard Wearing .....	6
Environmentally Friendly.....	6
Why use Bondor® building solutions? .....	7
Slower Traditional Methods.....	7
Summary of Physical Properties .....	8
Summary of Fire Properties .....	8
Summary of Environmental Properties.....	8

### Bondor's 3 Distinct Core Options .....9

EPS-FR.....	9
PIR .....	9
MW .....	9

### Insulated Walling ..... 11

Product Description .....	13
Equitilt Flameguard®.....	17
BondorPanel® .....	19
MetecnoPanel®.....	21
InsulWall® .....	23
LuxeWall® .....	25
LuxeWall FlameGuard® .....	25
DesignerWall® .....	27

### Insulated Roofing .....29

MetecnoSpan®.....	31
SolarSpan® .....	33
InsulRoof® .....	35
Equideck® Flat Pan .....	37
EconoClad® Roof.....	39
Roof End-Lap Solutions .....	41

### COLORBOND® Colour Range ..... 42

COLORBOND® Standard .....	42
COLORBOND® Metallic.....	42
COLORBOND® Matt.....	42
COLORBOND® Ultra Steel .....	42

### Innovative Accessories & Systems.....43



*Bondor® Industry Training & Professional Development sessions*



*Australian Standards Tested & Certified Products*



*Continual testing and innovation*



*Experienced design and specification service*

## Introduction

The Bondor® Product Guide is an overview of the steel faced insulated wall & roof panel systems Bondor® supplies to the Australian building market. This guide provides basic product information such as panel physical properties, spans, acoustic, fire and thermal performance.

Where greater detail is required please refer to our technical data sheets, product guides, installation manuals and standard drawings. This information is readily available from the Bondor website [www.bondor.com.au](http://www.bondor.com.au) or by contacting a local Bondor® representative on 1300 300 099.

## Why Bondor® are the Market Leaders

Bondor® is Australia's only manufacturer, distributor and installer of 'EPS-FR' cored panel, Factory Mutual Approved 'PIR' cored panel and Factory Mutual Approved 'MW' cored panel. As such, we are in a unique position to be able to offer our customers impartial advice on the right insulated panel solution to meet their needs.



## Support for Australian Standards & Local Manufacturing

Bondor® is an Australian manufacturer producing steel faced insulated panel systems in nine facilities around Australia. In over 65 years, we have manufactured in excess of 100 million square metres and installed in excess of 65 million square metres.

Bondor® products are physically tested and certified to conform to stringent Australian Standards and comply with the performance criteria when used in accordance with the National Construction Code.

Bondor® provide technical advice and support throughout the design and construction process. Our dedicated Technical Services team, local State representatives and construction supervisors are relied upon by our customers for the right advice based on Bondor's 65 years of construction experience and product developed in Australia.



## Global Experience

Bondor®, through its associated businesses, has links to the global Metecno Group. As such, we are able to access the latest trends in building product innovation and blend these with Australian experience and know how.

## Proven Partnerships



### BlueScope Steel



In business, your reputation is everything and minimizing risk makes sound business sense. Using only BlueScope® Steel for our panel skins ensures quality Australian steel products and transparent and reliable warranties.



### IPCA

Bondor is an active member of the Insulated Panel Council Australasia (IPCA), involved in developing the Industry Code of Practice for insulated panel construction. IPCA set out the principles and standards from design, manufacture, installation, maintenance and risk management of Insulated Panel in Australian buildings. The IPCA Code of Practice has been developed through industry leaders, external fire experts and the AFAC.



### Engineers Australia

Engineers Australia stands at the forefront of Australia's engineering community, serving as a premier professional organisation dedicated to advancing the field. With a commitment to excellence, innovation, and sustainability, Engineers Australia provides a dynamic platform for networking, knowledge exchange, and professional development. This esteemed organization plays a vital role in shaping the trajectory of engineering in Australia, fostering collaboration, and influencing policies to meet the evolving needs of the industry. Whether through educational programs, industry events, or advocacy efforts, Engineers Australia remains a trusted hub for engineers, contributing significantly to the growth and advancement of the engineering profession across the continent.



### AIA

#### The Australian Institute of Architects

The Australian Institute of Architects (AIA) is the peak body for architectural professionalism in Australia, representing 12,000 members. The Institute works to improve our built environment by promoting quality, responsible and sustainable design.

As supporting corporate partner to the AIA, Bondor® is actively involved in industry forums, technical CPD presentations and specific product and installation advice to AIA members.

# Colorbond®

THE COLOURS OF AUSTRALIA SINCE 1966

Still beautiful, after all these years.





## Quality Assurance



### Codemark

Australia's CodeMark Certification is a third-party building product certification scheme that authorises the use of new and innovative products in order to facilitate compliance with the NCC. Bondor has selected wall and roof products that are CodeMark certified and cover multiple performance criteria to meet today's building regulations.



### Factory Mutual (FM)

#### Approved Products and Systems

Factory Mutual (FM) Global is one of the worlds leading insurance companies and its product testing is an accepted international standard of product quality and performance in the insurance industry. A range of Bondor products and installation details have been FM approved, providing building owners and insurers a level of confidence in their performance in the face of fire or natural hazards such as cyclones.



### Green Rate

Green Rate certificates serve as a powerful symbol of commitment to sustainability in the built environment. These certificates are awarded to products and materials that meet stringent environmental standards, providing a transparent and credible way to assess their eco-friendly attributes. Whether for insulation, construction materials, or other components, a Green Rate certificate signifies a dedication to reducing environmental impact, energy efficiency, and overall sustainability. It serves as a valuable tool for architects, builders, and consumers seeking to make informed choices that contribute to a greener and more sustainable future.



### NATA

NATA accreditation provides a means of determining, formally recognising and promoting the competence of facilities to perform specific types of testing, inspection, calibration, and other related activities.



## Build Better with Bondor®

### Fast Build Times

Bondor's insulated panels fit together easily, require few tools for preparation, are easy to handle and install, leading to fast build times.

### Cost Effective

Bondor® wall and roof systems are able to achieve significantly long spans, reducing structural steel and support requirements in comparison to traditional cladding and roofing products.

### Design Flexibility

Coupled with Bondor's product performance is the design flexibility for specifiers to select from. We offer a wide array of exterior and interior finishes, modern colours with varying gloss levels, horizontal or vertical orientation to inspire creative and colourful building envelopes with Bondor's high performing and functional building systems.

### Low Maintenance & Hard Wearing

Bondor® panel systems use COLORBOND® steel for its high quality and consistent pre-finished look as well as ongoing low maintenance, tested and proven for use in the Australian environment.

### Environmentally Friendly

Bondor's wall and roof systems have a low impact on the environment with the use of zero ozone depleting insulation material and fully recyclable steel. Bondor® products deliver building owners and occupants with superior thermal performance and air leakage control, reducing the building envelope's heating and cooling costs, energy consumption and carbon footprint.





## Why use Bondor® building solutions?

### Bondor® Panel Systems Versus Traditional Systems

Bondor® products conform to the Australian Standards through rigorous testing and independent certification to ensure compliance requirements are met across various building application performance criteria as prescribed in the National Construction Code.

- Bondor® products meet Part J (NCC Vol. 1) by providing roofing, insulation and ceiling in one product, eliminating the need for unsightly and labour intensive wire mesh, bulk insulation and spacer battens.
- Insulated panels do not compress, crumble or take up moisture like other insulation types. This avoids the loss of thermal barrier effectiveness and efficiency over time, which effects traditional systems.
- Wall and roof panels lock together, forming an airtight seal that significantly reduces air leakage and improves energy efficiency, therefore saving on heating and cooling costs.
- Significantly longer spanning capability means a reduction in structural steel.
- Up to 50% quicker installation means faster end user occupancy and earlier cash flow generation, with weeks saved from building schedules.
- Ease of installation means less labour is required to install Bondor® insulated panel systems.
- Insulated panels eliminate thermal transfer and bridging.
- Savings in structural steel, mesh and labour means the project is completed much quicker to conventional methods.

### Slower Traditional Methods

#### Conventional Roofing / Walling Methods

Conventional commercial roofing and walling systems are labour intensive with multiple steps, subsequent increased costs and safety concerns.



Painstakingly labour intensive wire



Insulation rolls are "man-handled"



Many spacer battens secured



Roof sheet is then tacked in place



Poor thermal performance



Labour & material intensive

## Summary of Physical Properties

	Product	Core	Cover Width mm	Thickness mm	Declared R-Value m <sup>2</sup> K/W @23°C	Weight kg/m <sup>2</sup>	Max Length	Max Span At 1kPa	Acoustic Rw value	Features
Insulated Walling	MetecnoInspire®	PIR	1100	50-100	2.20-4.45	13.9-16.0	16m	5.3m	26	Architectural, Conceal Fix
	Equitiit®	EPS-FR	1200	50-250	1.20-6.05	12-14.9	16m	8.7m	24-25	Architectural, Conceal & Standard Fix
	Equitiit FlameGuard®	MW	1200**	50-150	1.36-4.09	15.6 - 25.6	11m	6.3m	28-30	Non-Combustible, FRL, FM Approved
	MetecnoPanel®	PIR	1100**	50-200	2.20-8.90	12-17.4	25m	8.1m	25-27	High Thermal Performance, IPCA Compliant, FM Approved, GreenRate Approved
	BondorPanel®	EPS-FR	1200	50-250	1.20-6.05	11.3-14	16m	8.9m	24-25	Proven Performance, Group 1, IPCA Compliant
	InsulWall®	EPS-FR	1200	90,140	2.15-3.40	11.8-12.5	16m	8.9m	24-25	Structural Wall System, CodeMark Certified
	LuxeWall®	EPS-FR	1200	50, 75	1.20-1.85	11.3-11.6	6.5m	1.2m	35-40	Luxury Wall System, CodeMark Certified
Insulated Roofing	MetecnoSpan® Rib	PIR	1000	40-100	1.85-4.55	10.7-13.2	up to 25m**	6.9m	24-25	Low Pitch Rib Roof, Long Spans, FM Approved, GreenRate Approved
	SolarSpan® Rib	EPS-FR	1000	50-200	1.20-4.85	10.6-12.7	up to 24m**	9.0m	24-25	Low Pitch Rib Roof, Long Spans, Local Avail
	InsulRoof® Corro	EPS-FR	1000	50-200	1.40-5.05	11.6-13.7	up to 12m**	9.0m	23-24	Corro Profile, Long Spans
	Equideck® Flat	EPS-FR	1200	50-250	1.20-6.05	11.3-14.0	16m	8.1m	24-25	Wide Flat Tray, Thermal Performance
	EconoClad® Rib	PIR	1000	25-100	1.15-4.55	5.6-8.7	16m	2.4m	23	Foilback/Embossed PVC Rib Roof

Max spans shown represent thickest panel option for multi-spans.

\*To achieve Group 1, the system must be installed per Bondor® instructions, otherwise Group 2 rating applies. Refer Bondor® for more information.

\*\*Refer to your local branch for alternative sizing as non-standard options available.

## Summary of Fire Properties

Core	EPS-FR	PIR	MW
Group Number	1 & 2	1 & 2	1 & 2
AS 1530.3 Spread of Flame Index	0	0	0
AS 1530.3 Smoke Developed Index	2-3	1-4	3
FM Approved 4880 & 4881 (No Height Restriction)		√	√
FM Approved 4471		√	
Fire Rated to AS 1530.4			-/60/60 -/90/90 -/180/180
Non-combustible AS 1530.1			√
BAL Rating	BAL 40	BAL 40 & BAL-FZ	BAL-40 & BAL-FZ
IPCA Code of Practice Compliant	√	√	√

Note: This summary is intended for Information purposes, for full product specifications refer to product data sheets. Before specifying a specific product ensure a full understanding of project requirements is taken into account and that full assessment is made of the performance and the suitability of the relevant Bondor® product. Bondor® does not warrant that any of its products are suitable for all applications and does not accept responsibility for product selection decisions based on the above information provided.

## Summary of Environmental Properties

Criteria	EPS-FR	PIR	MW
Zero ozone depleting insulant	√	√	√
Re-usable	√	√	√
Recyclable Steel	√	√	√
VOC	Low	Low	Low
Low Air Leakage	√	√	√
Consistent Insulation	√	√	√
Does not rot, settle and is vermin proof	√	√	√





## Bondor's 3 Distinct Core Options

Bondor's unique position enables us to provide unbiased advice across a wide range of roof and wall products. We offer the three globally recognised core options (EPS-FR, MW & PIR).

Bondor operates in every State with 9 manufacturing facilities across Australia. We continue to invest in Australian manufacturing, research and development and quality control.

Selecting high performance and conforming building materials is made easier for specifiers, builders and building occupants with Bondor's range of steel faced insulated panel products and its non-combustible or fire retardant core options.

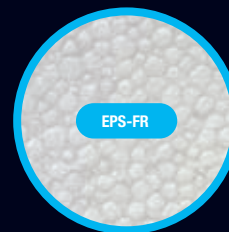

### EPS-FR

#### Expanded Polystyrene with Fire Retardant

is manufactured with a fire retardant raw material. The EPS-FR will melt when in contact with a flame, shrinking away from the flame and will self-extinguish when removed from the source.

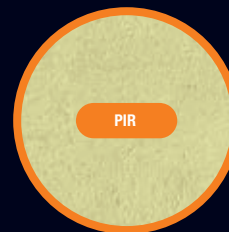

### PIR

#### Fire-Retardant Polyisocyanurate

(PIR) is a thermoset high strength foam, which will char when exposed to flame.



### MW

#### Mineral Wool

(MW) is molten rock which has been spun into a wool-like fibre and bound with resin and it does not burn when exposed to flames.





## Insulated Walling

Bondor® insulated walling systems combine high thermal efficiency and fire performance with a wide selection of attractive surface profiles and vibrant COLORBOND® colours, that inspire creative and sustainable designs for Australian building envelopes.







# metecnoinspire®



Colorbond®

## Product Description

PIR

MetecnoInspire® is an insulated architectural facade system that offers architects and designers an inspiring palette of colours, attractive surface profiles and excellent thermal properties. MetecnoInspire® also offers an innovative concealed fix system making it an ideal solution for Inspired facade or walling designs.

Core	PIR (Fire-retardant Polyisocyanurate)
Width (cover mm)	1100
Thickness (mm)	50, 60, 80, 100
Length	Up to 16m (check for availability)
External Material	BlueScope® Steel 0.5mm, 0.6mm G300
External Finishes	Single V Rib, V Rib, Double V Rib, Micro V Rib, Satinline Classic Cream™, Surfmist®, Paperbark®, Evening Haze®, Shale Grey™, Dune®, Cove™, Windspray®, Pale Eucalypt®, Gully™, Mangrove®, Wallaby®, Jasper®, Manor Red®, Terrain®, Basalt®, Woodland Grey®, Monument®, Ironstone®, Cottage Green®, Deep Ocean®, Night Sky®, Metallics: Galatic™, Cosmic™, Rhea™, Astro™, Aries™, Celestian™
Exterior Colour Options	
Internal Material	BlueScope® Steel 0.5mm, 0.6mm G300
Internal Finishes	Plain
Interior Colour Options	COLORBOND® Intramax™
Paint System	AS/NZS 2728 & AS 1397
Bushfire Attack Level	BAL-40 (all exposed core to be covered with flashing)
FM Approval	4880, 4881
Fire hazard properties	AS 5637.1
Group Number	1 & 2
Fire Indices	AS/NZS 1530.3
Ignitability Index	0
Spread of Flame Index	0
Heat Evolved Index	0
Smoke Index	4
Environmental	Zero Ozone Depleting Potential (ODP)
SMOGR <sub>ARC</sub>	<100
Acoustic Properties	Rw 26 depending on thickness

### Panel Properties

Panel Thickness (mm)	50	60	80	100
Typical Mass (kg/m <sup>2</sup> ) based on 0.6/0.5mm skins	13.9	14.3	15.1	16.0
Declared R-value (m <sup>2</sup> K/W) @23°C	2.20	2.65	3.55	4.45

Note: Contact us for other temperatures.

The technical information contained in this document cover a breadth of applications where MetecnoInspire® may be used, which may be outside the scope of our CodeMark certificate. Data specific can be found on CodeMark certification.





# equitilt®



**BAL40**

**Colorbond®**

## Equitilt®

**EPS-FR**

Equitilt® EPS-FR is an architectural walling panel system installed in a vertical or horizontal orientation that combines functionality with creative expression. Equitilt® is offered in a variety of metallic or standard COLORBOND® colours that can be mixed with surface profiles to deliver a stunning finish to a building's exterior and interior.

Core	EPS-FR (Expanded Polystyrene with fire retardant)						
Width (cover mm)	1200, 900 (non-std)						
Thickness (mm)	50, 75, 100, 150, 200, 250; non-std options available						
Length	Up to 16m (check for availability)						
External Material	0.6mm, 0.7mm G300 COLORBOND® steel						
External Finishes	Plain, Ribbed, Satinline, Shadowline Series 600/1200						
Exterior Colour Options	Standard & Non-Standard colours. Check for availability.						
Internal Material	0.6mm, 0.7mm G300 COLORBOND® steel						
Internal Finishes	Plain, Ribbed, Satinline, Shadowline Series 600/1200						
Interior Colour Options	Standard & Non-Standard colours. Check for availability.						
Paint System	AS/NZS 2728 & AS 1397						
Acoustic Properties	Rw 24 - 25 depending on thickness						
Material Group Numbers	Group 1 & 2						
Bushfire Attack Level	BAL-40 (all exposed core to be covered with flashing)						
Fire hazard properties	AS/NZS 1530.3						
Ignitability Index	0						
Spread of Flame Index	0						
Heat Evolved Index	0						
Smoke Index	2-3						
SMOGR <sub>ARC</sub>	<100						
Panel Thickness (mm)	50	75	100	125	150	200	250
Typical Mass (kg/m <sup>2</sup> ) based on 0.7/0.6mm skins	12.0	12.4	12.8	13.2	13.5	14.2	14.9
SL Grade Declared R-value (m <sup>2</sup> K/W) @23°C	1.20	1.80	2.40	3.00	3.60	4.85	6.05

Note: Contact us for other temperatures and different EPS-FR core grades.

The technical information contained in this document cover a breadth of applications where Equitilt® may be used, which may be outside the scope of our CodeMark certificate. Data specific can be found on CodeMark certification.







# equitilt - flameguard®



## Equitilt FlameGuard®

MW

Equitilt FlameGuard® is a non-combustible architectural walling panel system manufactured with a mineral wool fibre core material. Equitilt FlameGuard® is FM Approved to FM 4880 No Height Restriction. Equitilt FlameGuard® Plus is FM Approved to FM 4880 & FM 4881 No Height Restriction. These panels are recommended to be used where improved fire performance is required for insurance purposes in walling applications.

Core	MW (Mineral Wool)	
Width (cover mm)	1200, 1140**, 900** (**Minimum order required for non-standard widths.)	
Thickness (mm)	FlameGuard®: 50, 75 FlameGuard® Plus: 100, 150	
Length	Up to 11m (check for availability)	
External Material	0.6mm, 0.7mm G300 COLORBOND® steel	
External Skin	COLORBOND® steel	
External Finishes	Plain, Ribbed, Satinline, Shadowline Series 600/1200	
Exterior Colour Options	Standard & Non-Standard colours. Check for availability.	
Internal Material	0.6mm, 0.7mm G300 COLORBOND® steel	
Internal Skin	COLORBOND® steel	
Internal Finishes	Plain, Ribbed, Satinline, Shadowline Series 600/1200	
Interior Colour Options	COLORBOND® Intramax™	
Paint System	AS/NZS 2728 & AS 1397	
Acoustic Properties	Rw 28 - 30 depending on thickness	
Material Group Numbers	Group 1	
Bushfire Attack Level	FlameGuard®: BAL-40 FlameGuard® Plus: BAL-FZ (all exposed core to be covered with flashing)	
FM Approval	FlameGuard®: 4880 FlameGuard® Plus: 4880 & 4881	
Environmental	Zero Ozone Depleting Potential (ODP)	
Combustibility	AS 1530.1 Non-combustible	
Fire hazard properties	AS/NZS 1530.3	
Ignitability Index	0	
Spread of Flame Index	0	
Heat Evolved Index	0	
Smoke Index	3	
SMOGR <sub>ARC</sub>	<100	
Fire Resistance	AS 1530.4 FRL up to -/180/180	
	FlameGuard®	FlameGuard® Plus
Panel Thickness (mm)	50 75 100 150	
Typical Mass (kg/m <sup>2</sup> ) based on 0.6/0.6mm skins	15.6 18.1 20.6 25.6	
Declared R-value (m <sup>2</sup> K/W) @23°C	1.36 2.04 2.72 4.09	
Note: Contact us for other temperatures.		
Max. Lengths for Standard Supply		
Max Panel Length (m)	5 7 9 11 (Special Order)	

The technical information contained in this document cover a breadth of applications where Equitilt FlameGuard® may be used, which may be outside the scope of our CodeMark certificate. Data specific can be found on CodeMark certification.



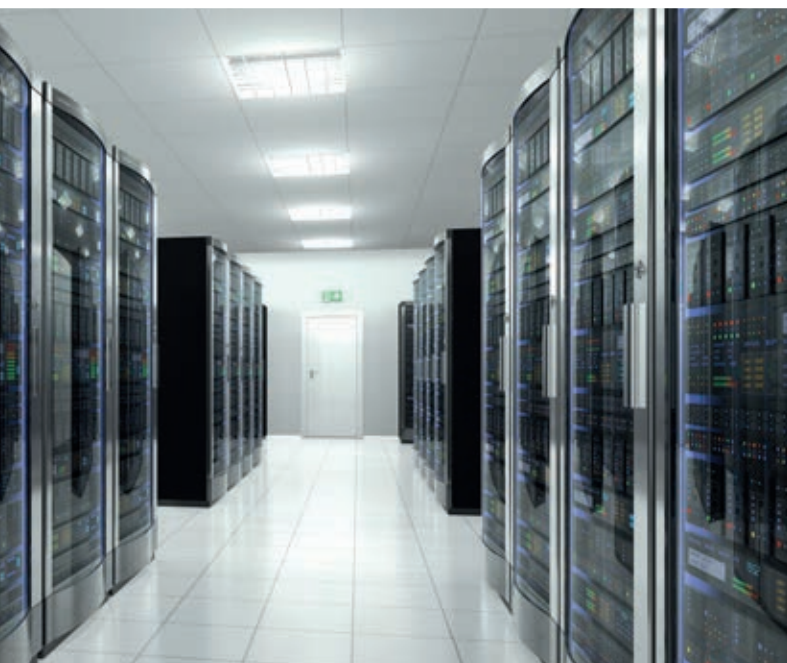

# bondorpanel®



**BAL40**

**Colorbond®**

## BondorPanel®

**EPS-FR**

BondorPanel® is a versatile and high performing insulated wall and ceiling panel used in controlled environments such as cold storage, food preparation areas and clean rooms, but extends its use to transportable offices, wall partitions and many other applications.

Core	EPS-FR (Expanded Polystyrene with fire retardant)						
Width (cover mm)	1200						
Thickness (mm)	50, 75, 100, 125, 150, 200, 250						
Length	Up to 16m (check for availability)						
External Material	BlueScope COLORBOND® Steel 0.6mm G300 CRP Grade						
External Finishes	Plain, Ribbed, Satinline						
Exterior Colour Options	COLORBOND® Intramax™ or other standard & non-standard colours						
Internal Material	BlueScope COLORBOND® Steel 0.6mm G300 CRP Grade						
Internal Finishes	Plain						
Interior Colour Options	COLORBOND® Intramax™						
Paint System	AS/NZS 2728 & AS 1397						
Acoustic Properties	Rw 24 - 25 depending on thickness						
Material Group Numbers	Group 1 & 2						
Bushfire Attack Level	BAL-40 (all exposed core to be covered with flashing)						
Fire hazard properties	AS/NZS 1530.3						
Ignitability Index	0						
Spread of Flame Index	0						
Heat Evolved Index	0						
Smoke Index	2-3						
SMOGR <sub>RC</sub>	<100						
Panel Thickness (mm)	50	75	100	125	150	200	250
Typical Mass (kg/m <sup>2</sup> )	11.3	11.6	12.0	12.3	12.7	13.3	14.0
SL Grade Declared							
R-value (m <sup>2</sup> K/W) @23°C	1.20	1.80	2.40	3.00	3.60	4.85	6.05

Note: Contact us for other temperatures and different EPS-FR core grades.

The technical information contained in this document cover a breadth of applications where BondorPanel® may be used, which may be outside the scope of our CodeMark certificate. Data specific can be found on CodeMark certification.





# metecnopanel®



Colorbond®

## MetecnoPanel®

PIR

MetecnoPanel® is a durable, insulated wall and ceiling panel with a PIR (Polyisocyanurate) fire-retardant core and high performing thermal properties. MetecnoPanel® is FM Approved to FM 4880 & 4881. No Height Restriction and is recommended where improved fire performance is required for insurance purposes. MetecnoPanel® is available in a variety of panel surface profiles and COLORBOND® colours to create an inspiring interior and exterior finish.

Core	PIR (Fire-retardant Polyisocyanurate)					
Width (cover mm)	1100					
Thickness (mm)	50, 75, 100, 125, 150, 200					
Length	Up to 25m (check for availability)					
External Material	BlueScope Steel 0.5mm, 0.6mm G300; Stainless Steel 0.55mm					
External Finishes	Plain, Fineline, Satinline, Ribbed					
Exterior Colour Options	Surfmist®. Other colours available subject to minimum order quantities.					
Internal Material	BlueScope® Steel 0.5mm, 0.6mm G300; Stainless Steel 0.55mm					
Internal Finishes	Plain, Fineline, Satinline, Ribbed					
Interior Colour Options	COLORBOND® Intramax™					
Paint System	AS/NZS 2728 & AS 1397					
Acoustic Properties	Rw 25 - 27 depending on thickness					
Material Group Numbers	Group 1 & 2					
Bushfire Attack Level	BAL-40 200mm - BAL-FZ (all exposed core to be covered with flashing)					
FM Approval	4880, 4881					
Environmental	Zero Ozone Depleting Potential (ODP)					
Fire hazard properties	AS/NZS 1530.3					
Ignitability Index	0					
Spread of Flame Index	0					
Heat Evolved Index	0					
Smoke Index	4					
SMOGR <sub>ARC</sub>	<100					
Panel Thickness (mm)	50	75	100	125	150	200
Typical Mass (kg/m <sup>2</sup> ) based on 0.6/0.6mm skins	12.0	13.0	14.0	14.7	15.5	17.4
Declared R-value (m <sup>2</sup> K/W) @23°C	2.20	3.30	4.45	5.55	6.65	8.90

Note: Contact us for other temperatures.

The technical information contained in this document cover a breadth of applications where MetecnoPanel® may be used, which may be outside the scope of our CodeMark certificate. Data specific can be found on CodeMark certification.

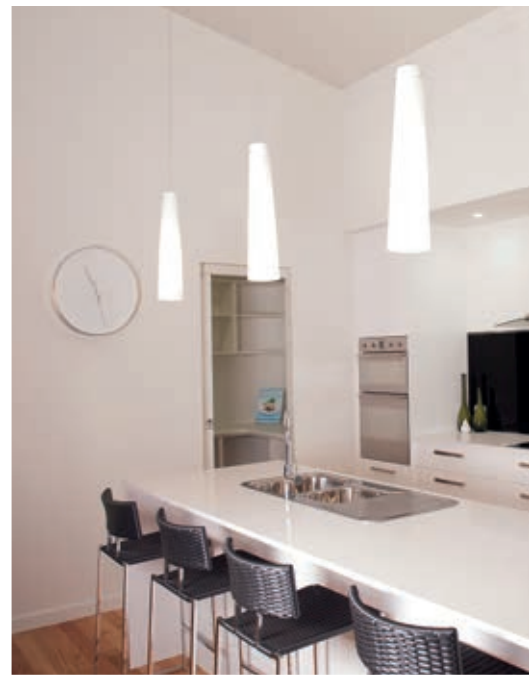

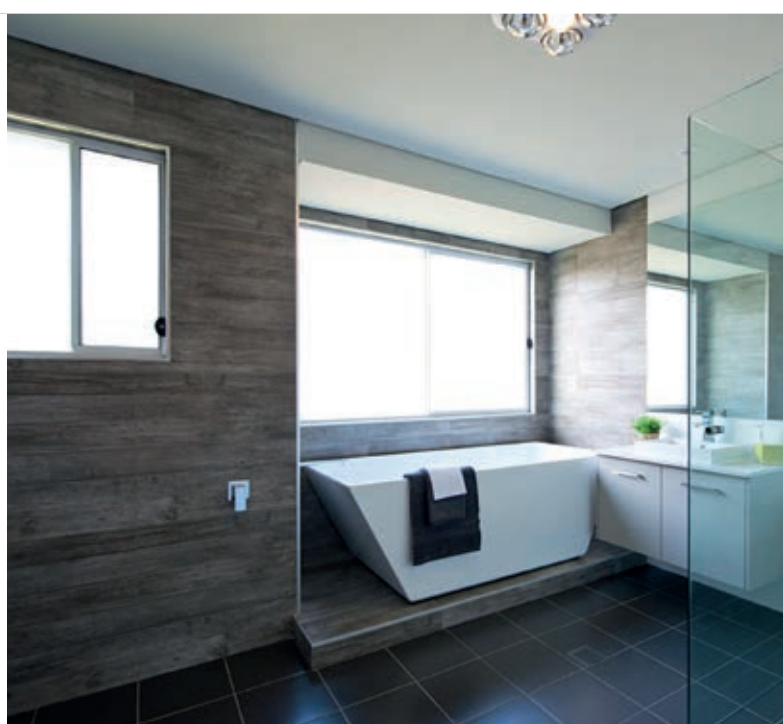

# insulwall®



**BAL40**

**Colorbond®**

## InsulWall®

**EPS-FR**

InsulWall® is a lightweight and structural insulated panel made from EPS-FR that is lined with a unique BlueScope® primed steel ready for third party coating systems such as a Dulux® Wash & Wear painted interiors and Dulux® Acratex® acrylic-render coated exteriors. InsulWall® is purpose designed to suit commercial applications as well as the residential housing, modular and renovation market. InsulWall® is available in thicknesses to suit 90mm interior walls and 140mm exterior walls and is available for use with the NCC CodeMark accredited InsulLiving® building system.

Core	EPS-FR (Expanded Polystyrene with fire retardant)	
Width (cover mm)	1200	
Thickness (mm)	90, 140	
Length	Up to 16m (check for availability)	
External Material	0.6mm G300 prime coated BlueScope® steel	
External Finishes	Plain	
Exterior Colour Options	External coating should strictly follow Dulux® DuSpec Specification. Dulux® Acratex® Coventry Coarse.	
Internal Material	0.6mm G300 prime coated BlueScope® steel	
Internal Finishes	Plain	
Interior Colour Options	Internal coating should strictly follow Dulux® DuSpec Specification. Broad walls - Dulux® Wash & Wear 101 Adv L/G. Kitchens - Dulux® Wash & Wear Kitchen. Bathrooms - Dulux® Wash & Wear Bathroom L/G for wet areas	
Paint System	AS/NZS 2728 & AS 1397	
Acoustic Properties	Rw 24 - 25 depending on thickness	
Bushfire Attack Level	BAL-40 (all exposed core to be covered with flashing)	
Fire hazard properties	AS/NZS 1530.3	
Ignitability Index	0	
Spread of Flame Index	0	
Heat Evolved Index	0	
Smoke Index	2-3	
SMOGR <sub>RC</sub>	<100	
Panel Thickness (mm)	90	140
Mass (kg/m <sup>2</sup> )	11.8	12.5
SL Grade Declared R-value (m <sup>2</sup> K/W) @23°C	2.15	3.40

Note: Contact us for other temperatures and different EPS-FR core grades.

The technical information contained in this document cover a breadth of applications where InsulWall® may be used, which may be outside the scope of our CodeMark certificate. Data specific can be found on CodeMark certification.

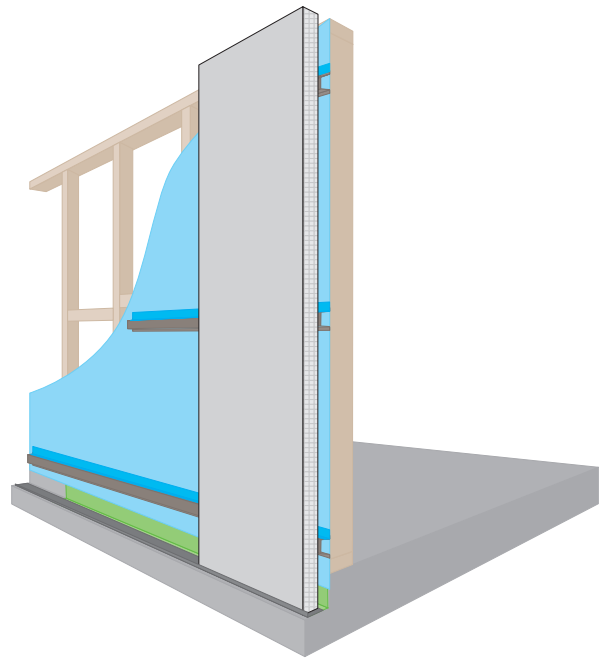



# luxewall®



Colorbond®

## LuxeWall®

EPS-FR

LuxeWall® is a modern, lightweight residential wall cladding solution developed with a concealed fixing system to fasten to timber and metal stud wall framing. The system uses architectural steel faced insulated wall cladding conceal fixed in a vertical orientation. LuxeWall® is available in standard wall thicknesses of 50mm & 75mm

Core	EPS-FR with CorePlus®
Width (cover mm)	1200, 900 <sup>^</sup>
Thickness (mm)	50, 75 (other thicknesses available on request) 90mm to 200mm wall thicknesses available via special order
Length	Up to 6.5m (check for availability)
External Material	BlueScope® COLORBOND® Steel 0.6mm G300
External Finishes	Plain, VJ <sup>^</sup>
Exterior Colour Options	Metallic Cosmic®, Metallic Astro®, Matt Basalt®, Matt Surfemist®
Internal Material	BlueScope® COLORBOND® Steel 0.6mm G300 with HygienePlus®
Internal Finishes	Plain
Interior Colour Options	Surfemist®
Paint System	AS/NZS 2728 & AS 1397
Acoustic Properties	Rw 35, 40 (EPS) *depending on construction
Material Group Numbers	Group 1
Bushfire Attack Level	BAL-40 (all exposed core to be covered with flashing)
Combustibility	AS 1530.1 Non-combustible (MW)
Fire hazard properties	AS/NZS 1530.3
Ignitability Index	0
Spread of Flame Index	0
Heat Evolved Index	0
Smoke Index	2-3
SMOGR <sub>RC</sub>	<100

### Total R-Value (m²K/W)

LuxeWall® panel thickness	Framing		Timber Framing				Steel Framing			
			50mm		75mm		50mm		75mm	
	Summer	Winter	Summer	Winter	Summer	Winter	Summer	Winter	Summer	Winter
System 1	1.78	1.88	2.37	2.51	1.72	1.82	2.31	2.44		
System 2	2.88	3.08	3.48	3.71	2.77	2.96	3.39	3.62		
System 3	3.31	3.54	3.91	4.18	3.13	3.36	3.77	4.03		

Notes:  
 System 1: LuxeWall® SL Grade & 10mm Plasterboard  
 System 2: LuxeWall® SL Grade with R1.5 Batts & 10mm Plasterboard  
 System 3: LuxeWall® SL Grade with R2.0 Batts & 10mm Plasterboard  
 For 13mm Plasterboard add 0.02 to above Total R-value. For 16mm Plasterboard add 0.04 to above Total R-value. Calculations based on AS/NZS 4859.1:2018 & AS/NZS 4859.2:2018.  
 Mean temperatures: Summer: 30°C, Winter: 15°C

The technical information contained in this document cover a breadth of applications where LuxeWall® may be used, which may be outside the scope of our CodeMark certificate. Data specific can be found on CodeMark certification.

# luxewall-flameguard®



Colorbond®

## LuxeWall FlameGuard®

MW

LuxeWall FlameGuard® Fire Rated System is a fire rated architectural boundary wall system tested and approved for both FRL 60/60/60 and FRL 90/90/90 for use in commercial and residential applications. LuxeWall FlameGuard® is a lightweight, conceal fixed and architecturally finished high performance wall product that simplifies installation on zero boundary properties where site access is difficult.

Core	MW (Mineral Wool)
Width (cover mm)	1200, 900 <sup>^</sup>
Thickness (mm)	50, 75 (other thicknesses available on request) 90mm to 200mm wall thicknesses available via special order
Length	Up to 6.5m (check for availability)
External Material	BlueScope® COLORBOND® Steel 0.6mm G300
External Finishes	Plain (Other options available) <sup>^</sup>
Exterior Colour Options	Standard, Matt & Metallic COLORBOND® options available
Internal Material	BlueScope® COLORBOND® Steel 0.6mm G300 with HygienePlus®
Internal Finishes	Plain
Interior Colour Options	Surfemist®
Paint System	AS/NZS 2728 & AS 1397
Acoustic Properties	Rw 40, 45* depending on construction
Material Group Numbers	Group 1
Bushfire Attack Level	BAL-FZ (all exposed core to be covered with flashing)
Combustibility	AS 1530.1 Non-combustible
Fire hazard properties	AS/NZS 1530.3
Ignitability Index	0
Spread of Flame Index	0
Heat Evolved Index	0
Smoke Index	3
Fire Resistance	AS 1530.4 FRL 90/90/90
SMOGR <sub>RC</sub>	<100

### Total R-Value (m²K/W)

LuxeWall FlameGuard® panel thickness	Framing		Timber Framing				Steel Framing			
			50mm		75mm		50mm		75mm	
	Summer	Winter	Summer	Winter	Summer	Winter	Summer	Winter	Summer	Winter
System 1	1.80	1.91	2.42	2.55	1.75	1.85	2.35	2.49		
System 2	2.91	3.11	3.53	3.76	2.80	3.00	3.44	3.67		
System 3	3.34	3.57	3.96	4.22	3.16	3.39	3.82	4.08		

Notes:  
 System 1: LuxeWall FlameGuard® & 10mm Plasterboard  
 System 2: LuxeWall FlameGuard® with R1.5 Batts & 10mm Plasterboard  
 System 3: LuxeWall FlameGuard® with R2.0 Batts & 10mm Plasterboard  
 For 13mm Plasterboard add 0.02 to above Total R-value. For 16mm Plasterboard add 0.04 to above Total R-value. Calculations based on AS/NZS 4859.1:2018 & AS/NZS 4859.2:2018.  
 Mean temperatures: Summer: 30°C, Winter: 15°C

The technical information contained in this document cover a breadth of applications where LuxeWall FlameGuard® may be used, which may be outside the scope of our CodeMark certificate. Data specific can be found on CodeMark certification.

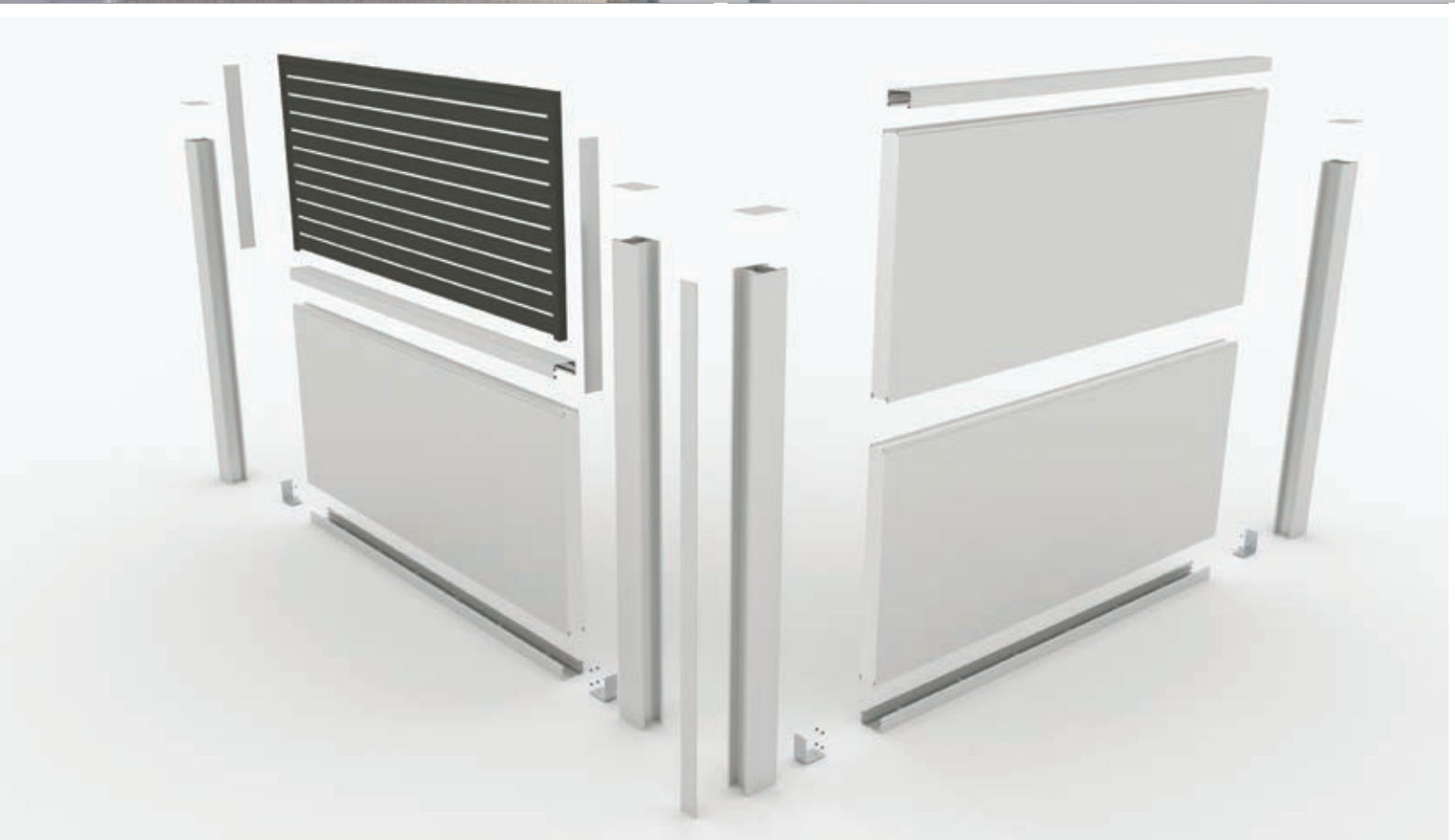



# designerwall®

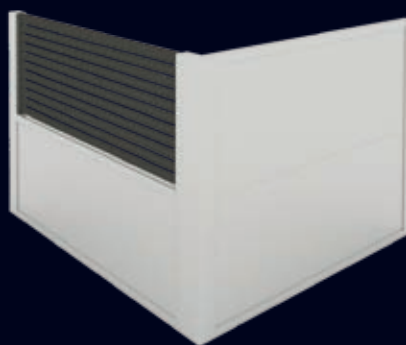

 **BAL40**

**Colorbond®**

## DesignerWall®

**EPS-FR**

DesignerWall® is a modular acoustic barrier and feature fence system for retail, commercial and residential projects available in either a Pre-finished range or a 'Texture Ready' coating.

Module Column Centre Spacing (mm)	2400, 3000
Module Panel Width (mm)	2300, 2900. (Non-standard available depending on request.)
Module Height (mm)	900-3000 (depending on module height & column engineering)
Module Panel Height (mm)	900, 1200
Module Panel Thickness (mm)	75
Column Type	Allegro Series. (Other engineered column options available.)
Column Size (mm)	Width: 140mm Depth: 105mm
Column Material	Aluminium
Module Panel Exterior Material	BlueScope® COLORBOND Steel or 'Render-Ready' pre-primed steel
Module Panel Exterior Colour Options	Woodland Grey®, Shale Grey™, (other colours available subject to minimum order quantities and availability)
Bushfire Attack Level	BAL-40 (all exposed core to be covered with flashing)
Acoustic Properties	Rw 25 (see acoustic report for dB reduction values)
Wind Regions	A & B





## Insulated Roofing

Bondor® insulated roof systems outperform traditional roofing materials capable of longer spans, higher thermal performance, faster installation and is approved for use in cyclonic regions.







# metecnospan®

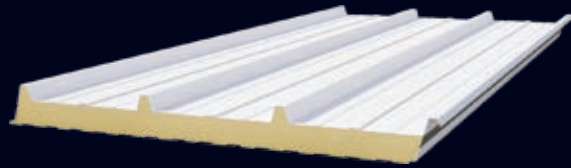

**Colorbond®**

**PIR**

## MetecnoSpan®

MetecnoSpan® is a roofing system that combines the roofing, insulation and ceiling in one roof panel with a fire-retardant polyisocyanurate (PIR) core. MetecnoSpan® is FM Approved (4880, 4881 & 4471) and is recommended where FM Approved products is required. MetecnoSpan® is capable of long spans and high thermal performance and is used mainly in commercial and industrial roofing applications.

Core	PIR (Fire-retardant Polyisocyanurate)			
Width (cover mm)	1000			
Thickness (mm)	40, 60, 80, 100			
Length	Up to 25m (check for availability)			
External Material	0.42mm COLORBOND® steel			
External Finishes	Trapezoidal Profile			
Exterior Colour Options	Surfmist® and Zinalume™. Other colours available subject to minimum order quantities.			
Internal Material	0.5mm G300 COLORBOND® steel			
Internal Finishes	Plain, Fineline, Satinline, V Rib			
Interior Colour Options	Surfmist®			
Pitch	2 degree minimum			
Paint System	AS/NZS 2728 & AS 1397			
Acoustic Properties	Rw 24 - 25 depending on thickness			
Material Group Numbers	Group 1 & 2			
Bushfire Attack Level	BAL-40 (all exposed core to be covered with flashing)			
FM Approval	4471, 4880, 4881			
Environmental	Zero Ozone Depleting Potential (ODP)			
Fire hazard properties	AS/NZS 1530.3			
Ignitability Index	0			
Spread of Flame Index	0			
Heat Evolved Index	0			
Smoke Index	1			
SMOGR <sub>ARC</sub>	<100			
Panel Thickness (mm)	40	60	80	100
Typical Mass (kg/m <sup>2</sup> ) based on 0.42/0.5mm skin	10.7	11.6	12.7	13.2
Declared R-value (m <sup>2</sup> K/W) @23°C	1.85	2.75	3.65	4.55

Note: Contact us for other temperatures.

The technical information contained in this document cover a breadth of applications where MetecnoSpan® may be used, which may be outside the scope of our CodeMark certificate. Data specific can be found on CodeMark certification.







# solarspan<sup>®</sup>

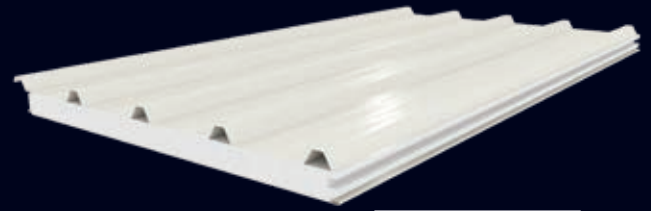

**Colorbond<sup>®</sup>**

## SolarSpan<sup>®</sup>

**EPS-FR**

SolarSpan<sup>®</sup> is a long-spanning commercial and residential insulated roof panel system that combines roofing, EPS-FR insulation and a pre-painted ceiling in one durable, functional and attractive roof panel. This all-in-one roofing solution is manufactured using Australian-made COLORBOND<sup>®</sup> steel for durability and is installed in a variety of applications including educational facilities, multi-residential housing and retail facilities and is tested for use in cyclonic regions.

Core	EPS-FR (Expanded Polystyrene with fire retardant)						
Width (cover mm)	1000						
Thickness (mm)	50, 75, 100, 125, 150, 175, 200						
Length	Up to 24m (check for availability)						
External Material	0.42mm G550 COLORBOND <sup>®</sup> pre-painted steel						
External Finishes	High-Rib Trapezoidal Profile						
Exterior Colour Options	Classic Cream <sup>™</sup> , Surfmist <sup>®</sup> , Paperbark <sup>®</sup> , Shale Grey <sup>™</sup> , Dune <sup>®</sup> , Pale Eucalypt <sup>®</sup> , Manor Red <sup>®**</sup> , Basalt <sup>®^</sup> , Woodland Grey <sup>®^**</sup>						
Internal Material	0.6mm G300 COLORBOND <sup>®</sup> pre-painted steel						
Internal Finishes	Plain, VJ						
Interior Colour Options	Classic Cream <sup>™</sup> , Surfmist <sup>®</sup>						
Pitch	2 degree minimum, refer Bondor <sup>®</sup>						
Paint System	AS/NZS 2728 & AS 1397						
Acoustic Properties	Rw 24 - 25 depending on thickness						
Material Group Numbers	Group 1 & 2						
Bushfire Attack Level	BAL-40 (all exposed core to be covered with flashing)						
Fire hazard properties	AS/NZS 1530.3						
Ignitability Index	0						
Spread of Flame Index	0						
Heat Evolved Index	0						
Smoke Index	2-3						
SMOGR <sub>RC</sub>	<100						
Panel Thickness (mm)	50	75	100	125	150	175	200
Typical Mass (kg/m <sup>2</sup> )	10.6	10.9	11.3	11.6	12.0	12.3	12.7
SL Grade Declared R-value (m <sup>2</sup> K/W) @23°C	1.20	1.80	2.40	3.00	3.60	4.25	4.85

Note: Contact us for other temperatures and different EPS-FR core grades.

The technical information contained in this document cover a breadth of applications where SolarSpan<sup>®</sup> may be used, which may be outside the scope of our CodeMark certificate. Data specific can be found on CodeMark certification.



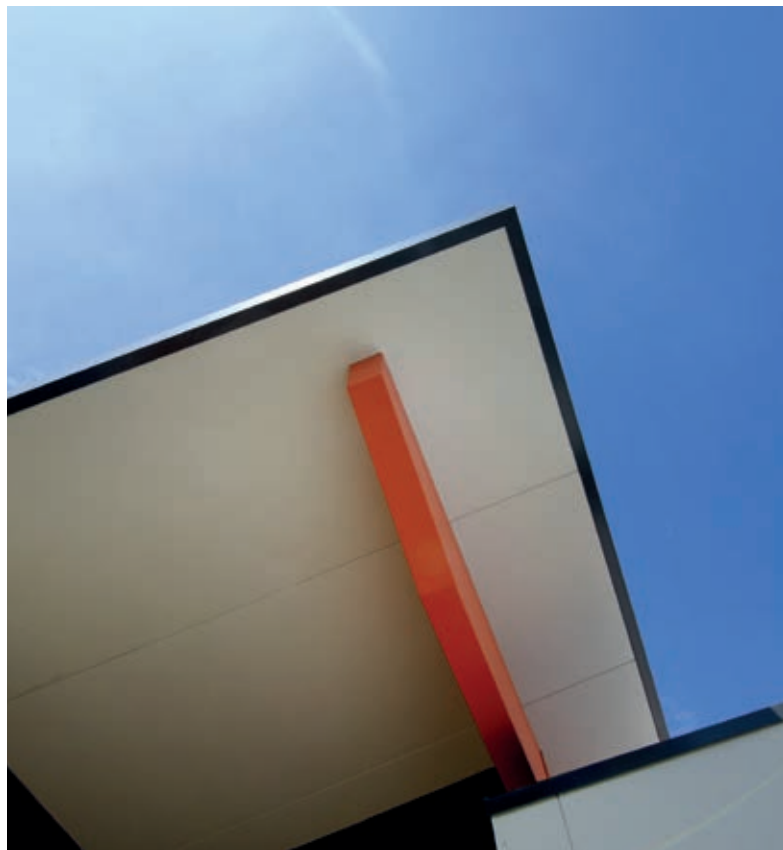

# insulroof®

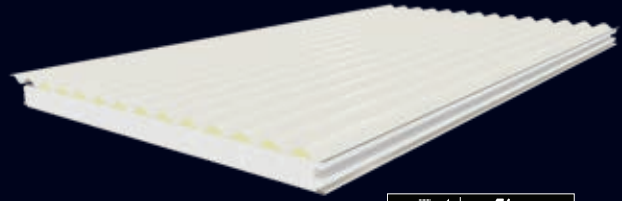

**Colorbond®**

## InsulRoof®

**EPS-FR**

**PUR**

InsulRoof® is a long-spanning insulated roof panel that features a corrugated roof profile and a pre-finished steel ceiling lining encased in Bondor's new proprietary dual layered insulating core technology comprising of EPS-FR and PUR.

This all-in-one roofing solution is manufactured using Australian-made BlueScope® COLORBOND® steel for durability and is ideal for a variety of applications including housing, multi-residential, commercial and industrial roofing applications where a corrugated roof profile is desired. SupaCore® is a proprietary and world-first insulating core technology developed by Bondor® to deliver dual layers of high performance insulation and bonding strength.

Core	EPS-FR (Expanded Polystyrene with fire retardant) PUR (Polyurethane Foam)					
Width (cover mm)	1000					
Thickness (mm)	50, 75, 100, 125, 150, 200					
Length	Up to 12m (check for availability)					
External Material	0.42mm G550 COLORBOND® steel					
External Finishes	Corrugated					
Exterior Colour Options	Classic Cream™, Surfemist®, Paperbark®, Shale Grey™, Dune®, Pale Eucalypt®, Manor Red®**, Basalt®^, Woodland Grey®^**, Zinalume™					
Internal Material	0.6mm G300 COLORBOND® steel					
Internal Finishes	Plain, VJ					
Interior Colour Options	Classic Cream™, Surfemist®					
Pitch	5 degree minimum					
Paint System	AS/NZS 2728 & AS 1397					
Acoustic Properties	Rw 23 - 24 depending on thickness					
Material Group Numbers	Group 1 & 2					
Bushfire Attack Level	BAL-40 (all exposed core to be covered with flashing)					
Fire hazard properties	AS/NZS 1530.3					
Ignitability Index	0					
Spread of Flame Index	0					
Heat Evolved Index	0					
Smoke Index	1					
SMOGR <sub>ARC</sub>	<100					
Panel Thickness (mm)	50	75	100	125	150	200
Typical Mass (kg/m <sup>2</sup> )	11.6	11.9	12.3	12.6	13.0	13.7
SL Grade Declared R-value (m <sup>2</sup> K/W) @23°C	1.40	2.00	2.60	3.20	3.80	5.05
Note: Contact us for other temperatures and different EPS-FR core grade.						

The technical information contained in this document cover a breadth of applications where InsulRoof® may be used, which may be outside the scope of our CodeMark certificate. Data specific can be found on CodeMark certification.





# equideck®



Colorbond®

## Equideck®

EPS-FR

Equideck® EPS-FR insulated roofing panel system provides a flat and standing-seam like roof profile made from COLORBOND® steel, a pre-painted ceiling underside and high performance insulated core in an all-in-one roofing panel. Equideck® is made using Australian-made COLORBOND® steel for durability and delivers a long-spanning and thermally efficient roof.

Core	EPS-FR (Expanded Polystyrene with fire retardant)
Width (cover mm)	1200
Thickness (mm)	50, 75, 100, 125, 150, 200, 250 (non-std options available)
Length	Up to 16m (check for availability)
External Material	BlueScope® COLORBOND® Steel 0.6mm G300
External Finishes	Plain, Ribbed, Satinline
Exterior Colour Options	Surfmist®
Internal Material	BlueScope® COLORBOND® Steel 0.6mm G300
Internal Finishes	Plain
Interior Colour Options	Surfmist®
Pitch	3 degrees minimum
Paint System	AS/NZS 2728 & AS 1397
Acoustic Properties	Rw 24 - 25 depending on thickness
Material Group Numbers	Group 1 & 2
Bushfire Attack Level	BAL-40 (all exposed core to be covered with flashing)
Fire hazard properties	AS/NZS 1530.3
Ignitability Index	0
Spread of Flame Index	0
Heat Evolved Index	0
Smoke Index	2-3
SMOGR <sub>acc</sub>	<100

Panel Thickness (mm)	50	75	100	125	150	200	250
Typical Mass (kg/m <sup>2</sup> )	11.3	11.6	12.0	12.3	12.7	13.3	14.0
SL Grade Declared R-value (m <sup>2</sup> K/W) @23°C	1.20	1.80	2.40	3.00	3.60	4.85	6.05

Note: Contact us for declared values, other temperatures and different EPS-FR core grades.

The technical information contained in this document cover a breadth of applications where Equideck® may be used, which may be outside the scope of our CodeMark certificate. Data specific can be found on CodeMark certification.

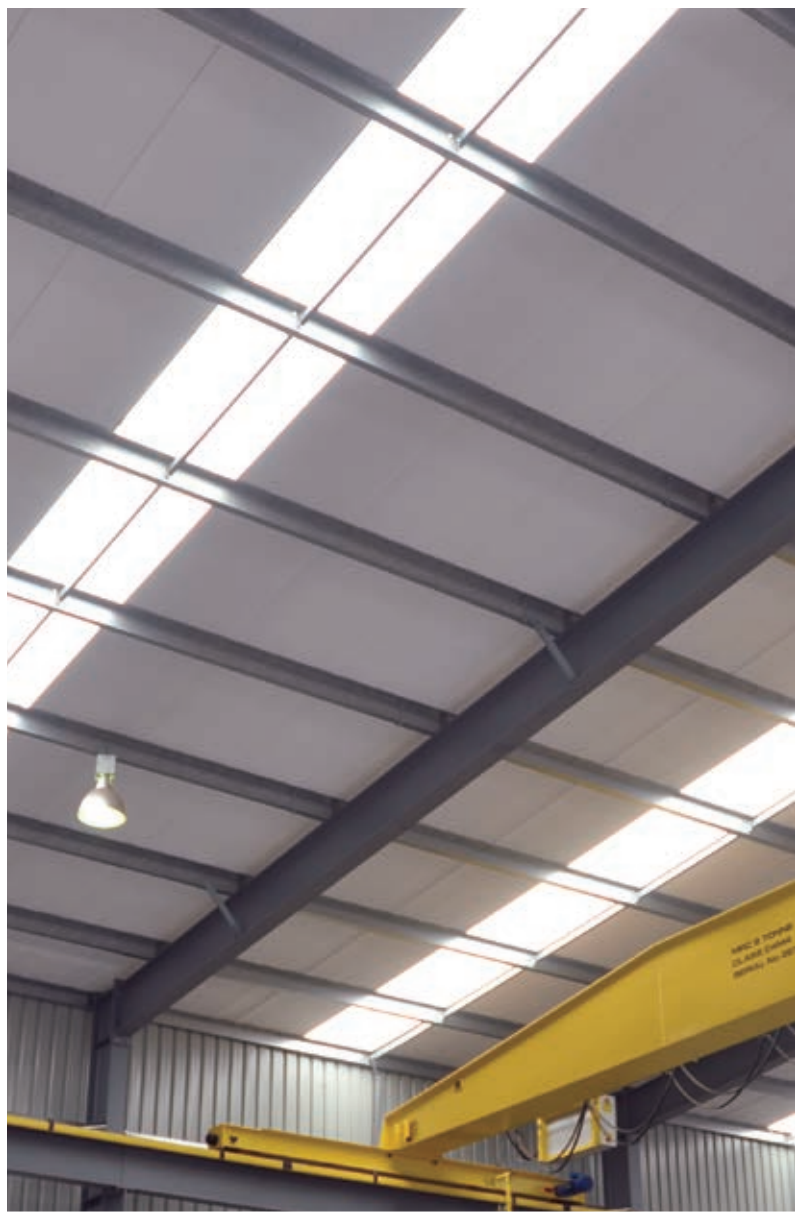

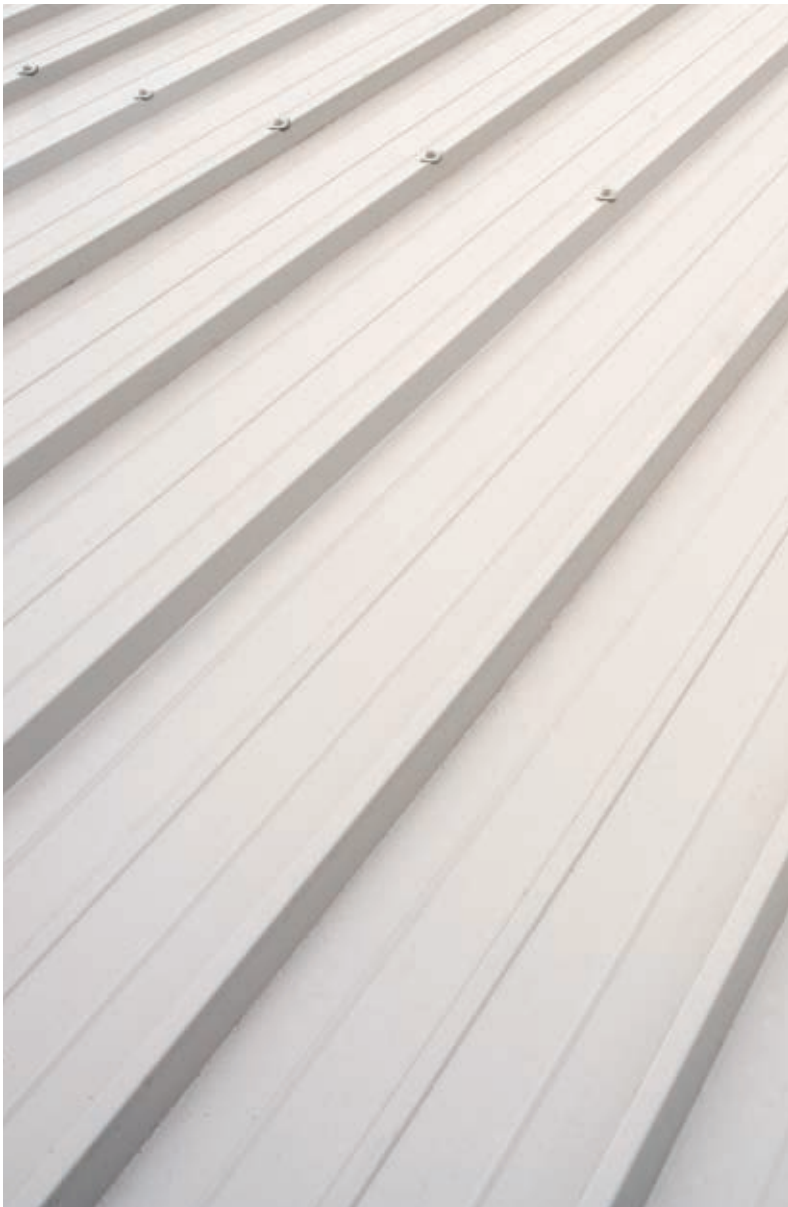

# econoclاد®

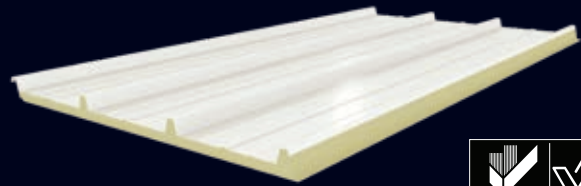

**Colorbond®**

## EconoClad®

**PIR**

EconoClad® is a high performing and low cost roofing or walling insulated panel suitable for industrial and commercial cladding. EconoClad® has a non-ozone depleting fire-retardant PIR core bonded between a hi-tensile COLORBOND® or Zinalume™ steel roof and a silver/white/black, multi-layered foil/fibreglass/PVC flexible facings on the internal side. EconoClad® is a fast, economical and practical roof or wall cladding option.

Core	PIR (Fire-retardant Polyisocyanurate)
Width (cover mm)	1000
Thickness (mm)	25, 40, 60, 80, 100
Length	Up to 16m (check for availability)
External Material	0.42mm COLORBOND steel
External Finishes	High-Rib Trapezoidal Cladding Profile
Exterior Colour Options	Surfmist® and Zinalume®. Other colours available subject to minimum order quantities.
Internal Material	Lightweight Thermal Foil, Fibreglass, PVC <sup>c</sup>
Internal Finishes	Foilback, Embossed PVC <sup>c</sup>
Interior Colour Options	Bright White, Silver, Black
Pitch	2 degree minimum
Paint System	AS/NZS 2728 & AS 1397
Acoustic Properties	Rw 23
Material Group Numbers	Group 2
Bushfire Attack Level	BAL-40 (all exposed core to be covered with flashing)
FM Approval	4880 <sup>b</sup> (b - When used as internal wall and ceiling EconoClad can achieve FM approval)
Environmental	Zero Ozone Depleting Potential (ODP)
Fire hazard properties <sup>c</sup>	AS/NZS 1530.3
Ignitability Index	0
Spread of Flame Index	0
Heat Evolved Index	0
Smoke Index	1

Panel Thickness (mm)	25	40	60	80	100
Typical Mass (kg/m <sup>2</sup> )	5.6	6.3	7.1	7.9	8.7
Declared R-value (m <sup>2</sup> K/W) @23°C	1.15	1.85	2.75	3.65	4.55

Note: Contact us for other temperatures.  
c - For Fire Hazard Properties of EconoClad® with PVC internal facing, contact Metecno®.

The technical information contained in this document cover a breadth of applications where EconoClad® may be used, which may be outside the scope of our CodeMark certificate. Data specific can be found on CodeMark certification.



securelap<sup>®</sup>

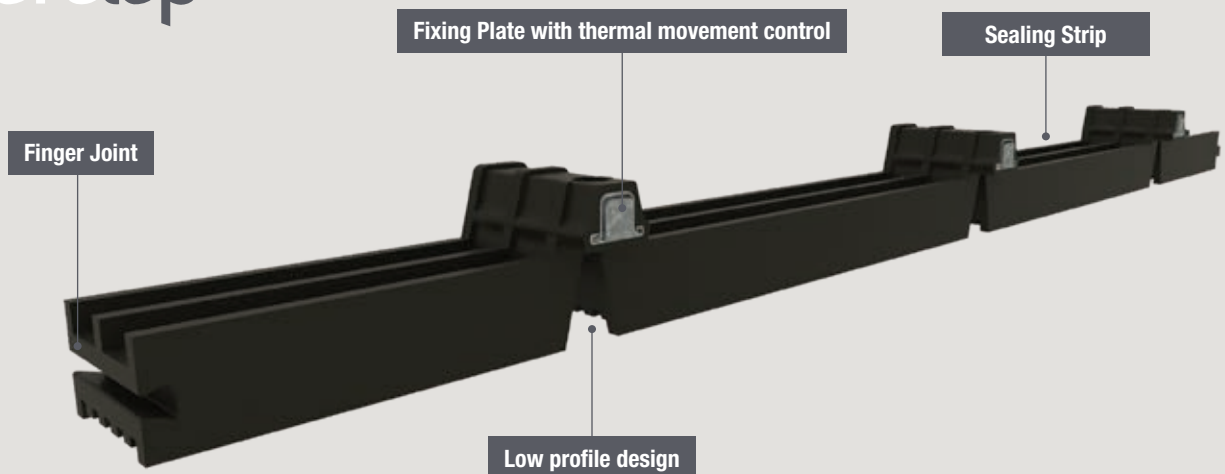



# securelap® / solarlap®

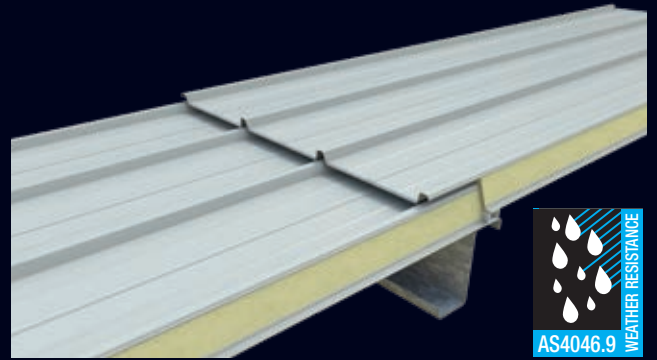

## Roof End-Lap Solutions

SecureLap® is a unique roof lap jointing system that changes the way low pitch long run insulated roofing is designed and installed in Australia. SecureLap® provides a solution to existing troublesome “sheet to sheet end-lap” and offers a real alternative to the more expensive “expansion joint” system which requires extra purlins and purlin cleat modifications. The SecureLap® system is significantly easier to install than current lapping alternatives removing the need for sealant and butyl tape which is both messy and difficult to assure a secure seal. This patented and cutting edge technology is designed to provide the additional water ingress security while preserving the integrity of the existing roof warranty. SecureLap® is the only option for the ultimate in end lap protection.

## Advantages

- Unique end-lap system purpose-made for low pitch & long monoslope roofing
- SecureLap® seal removes reliance on sealant or butyl tape
- Allows the turn-up and turn-down of roof pans for added water ingress security
- Designed to allow thermal expansion and contraction to suit Australian conditions
- Low profile design for visual roof continuity and uniform purlin height
- Significantly improves installation time and reduces labour costs
- CSIRO tested and conforms to Australian Standards AS/NZ 4046.9
- BlueScope Steel endorsed warranties

### Images

Top-Right: MetecnoSpan® shown with SecureLap® sealing strip applied.  
Middle-Right: MetecnoSpan® overlap shown with SecureLap® installed.  
Top-Left: MetecnoSpan® and SecureLap® shown fixed to commercial framing.

# solarlap®

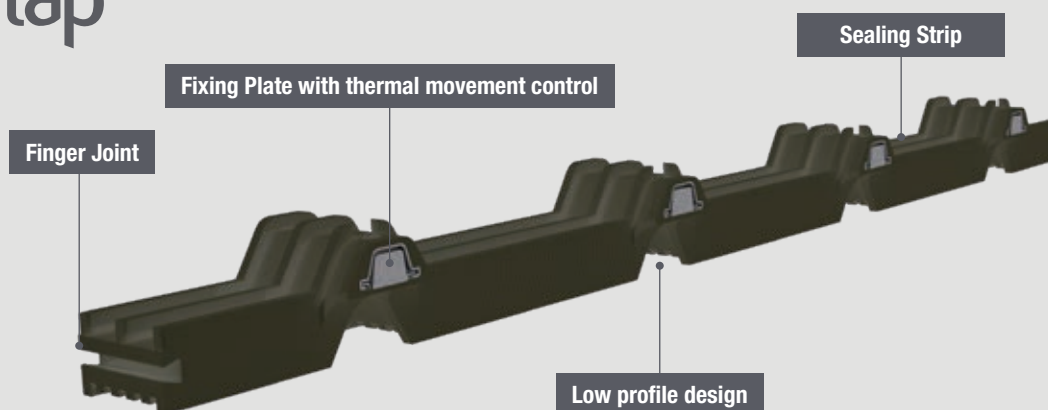

# COLORBOND® Colour Range

Bondor® has access to the full range of COLORBOND® Standard, Metallic, Matt & Ultra\* colours as well as custom colour options dependant on order quantities and project time frames. Speak with your local Bondor® branch for availability of stocked, standard COLORBOND® and custom colours to suit your project requirements.



## COLORBOND® Standard



## COLORBOND® Metallic

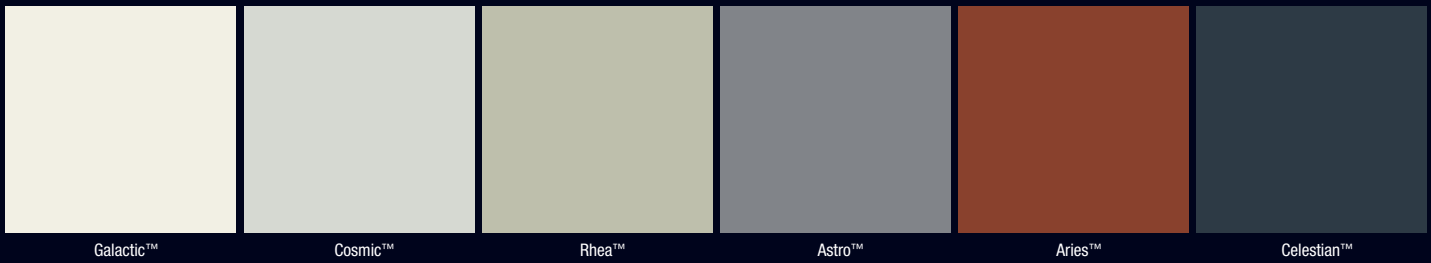

## COLORBOND® Matt



^ Check with NCC for permissible solar absorptance before selecting the exterior roof colour. Darker colours may be warranted for use in limited regions refer to [www.bondor.com.au](http://www.bondor.com.au) as this information is subject to change.

# Innovative Accessories & Systems

For over 65 years, Bondor® has led innovation in insulated roofing and walling products delivering a range of purpose-made accessories and building systems that meet not only the application performance needs but the local requirements of both the Australian Standards and National Construction Code (NCC).

The Australian building industry relies on Bondor's local knowledge, experience and continuous innovation within insulated panel products to design compliant building systems that meet the harsh demands of the Australian environment.

Such innovation includes the patented and world-first SecureLap® end lap solution for metal insulated roofing which is designed to provide additional water ingress security while preserving the integrity of the existing roof warranty unlike solutions inherited from overseas which do not consider Australian weather conditions including higher rainfall intensity, wind conditions, UV and thermal exposure.

## Preformed Corners

Bondor's national fabrication footprint and capability enables local access to a range of prefabricated insulated wall sections and corners across our range of insulated wall products. Preformed corners offer a high level finish without the need for corner flashings. Your local Bondor® branch can assist with bespoke designs of preformed corners in both vertical and horizontal orientation.

## Flashings & Trims

Bondor® has a range of wall and roof accessories for specific product use and applications developed over the last 65 years. Speak to our Bondor® branch regarding a range of flashing details, aluminium trims and capping systems to suit both application performance and aesthetic requirements.

## Sun Hoods & Blades

Bondor® can assist with a range of architectural commercial shaded devices and structures including sunhoods and blades used on many commercial buildings. Bondor shaded structures are pre-finished, hard wearing and inherit the thermal and structural benefits of Bondor's insulated panel range.

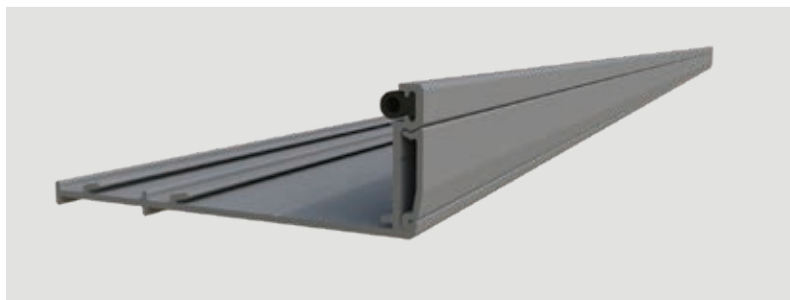
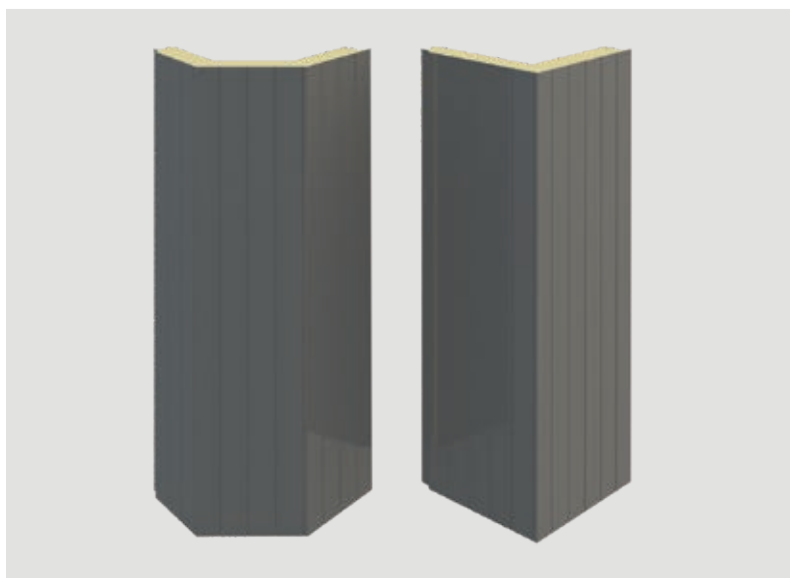
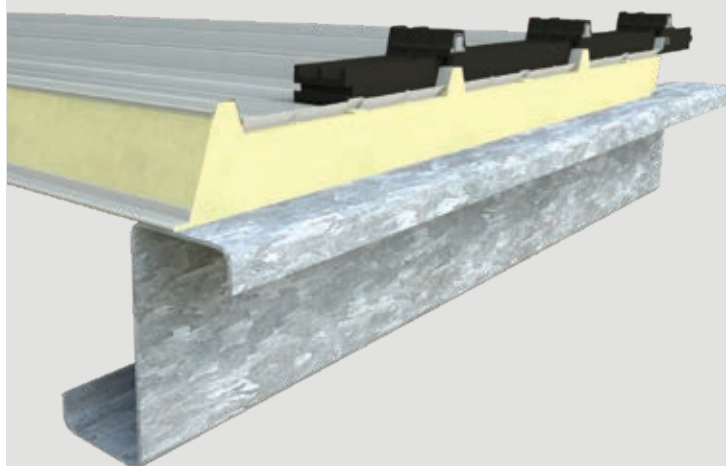



Leaders in Thermal & Architectural Building Solutions

[www.bondor.com.au](http://www.bondor.com.au)

1300 300 099

**BRISBANE/EXPORT**

103 Ingram Road Acacia Ridge QLD 4110  
Ph: (07) 3323 8500 Fax: (07) 3323 8501

**ADELAIDE**

70-72 Rundle Road Salisbury South SA 5106  
Ph: (08) 8282 5000 Fax: (08) 8282 5099

**LAUNCESTON**

7 Connector Park Drive Kings Meadows TAS 7249  
Ph: (03) 6335 8500 Fax: (03) 6335 8544

**PERTH**

17 Gauge Circuit Canning Vale WA 6155  
Ph: (08) 9256 0600 Fax: (08) 9256 0620

**MELBOURNE**

6 Dunmore Drive, Truganina VIC 3029  
Ph: (03) 8326 8000 Fax: (03) 8326 8099

**SYDNEY**

49-53 Newton Road Wetherill Park NSW 2164  
Ph: (02) 9609 0888 Fax: (02) 9729 1114